

Influence of Tool Pin Profile and Welding Parameters on Tensile Strength of Aluminium Alloy 5052 during FSW

Parminder Pal Singh, Gurmeet Singh Cheema and Amrinder Singh Kang

Department of Mechanical Engineering, BGIET, Sangrur - 148001, Punjab, India;
pps11may76@gmail.com, gcheemamand@gmail.com, amardeepkang@gmail.com

Abstract

The friction stir welding (FSW) is a solid state welding process. It uses non-consumable tool for joining plates with advantages such as low distortion, no shielding gas required and fine recrystallized microstructure. FSW parameters such as tool rotation, welding speed, tool geometry, axial force and tool plunge depth play an important role during welding. In the present work, FSW between the 6mm thick AA5052 aluminium alloy plates was investigated with the combination of two different tool pin profile (Taper Pin-Left Hand Threaded (LHT) and Square Pin) at welding speeds of 30mm/min and 40mm/min with tool rotation speed 850rpm and 1250 rpm. Tensile testing was carried out and comparative study was done to know the best parameter from the selected ones. Maximum tensile strength 378.12 N/mm² was obtained with taper pin-LHT at welding speed 40mm/min with tool rotation 1250rpm.

General Terms: Friction Stir Welding (FSW), Heat Affected Zone (HAZ), Nugget, Stir Zone (SZ), Thermo-Mechanically Affected Zone (TMAZ), Taper Pin Left Hand Thread (LHT), FSWed

Keywords: Tensile Strength, Tool Pin Profile, AA5052, FSW

1. Introduction

Welding is a fabrication process that joins materials by causing fusion. Welding has been playing an important role in every manufacturing industry in which further automobile industry is the major concerned industry. A number of processes can be engaged for welding different metals and thermoplastics depending upon their properties, condition and service of joints. Heat and pressure may also be used in conjunction with heat to produce a weld. Welding can be classified on the basis of source of

heat and type of interaction i.e. fusion welding or solid state welding. Friction Stir Welding (FSW) is one of the innovated latest welding techniques that have found a major role in automotive sector. FSW is a solid state joining technique invented and developed by [Thomas et al]¹ at The Welding Institute (TWI), UK, in 1991. FSW utilizes the heat produced between the material and a non-consumable rotating tool to join the work pieces. The rotation of tool causes a plasticized region of material which rotates about the tool. As the tool is feed through

*Author for correspondence

the material, the material on the leading edge enters the plasticized region and is swept around to the back of the tool due to tool rotation and is left to form a solid joint. In order to obtain a proper weld it is also necessary for there to be a shoulder above the pin, which rides along the surface of the work piece in intimate contact, while the pin is submerged in the work piece providing the heating and stirring. The shearing of the material at the interface between the tool and the material is the main source of energy for the weld.

1.1 Weld Region Terminology

The friction stir welded zone as shown in **Figure 1.3** can be divided into the following four zones²:

- The *parent material* (PM) is labeled as region 'A' which is not affected by the thermal and mechanical processes.
- The *heat affected zone* (HAZ) labeled as 'B' is common to all welding processes. This zone is only

affected thermally but not deformed during welding.

- The *thermo-mechanically affected zone* (TMAZ) labeled as 'C' extends from the advancing side HAZ to the retarding side HAZ. This zone experiences the thermal heating and mechanical shearing. In this region the strain and temperature are lower and effect of welding on the microstructure is correspondingly less.
- The *stir zone* (SZ), also called "Weld Nugget" labeled as 'D' is a region of heavily deformed material that approximately corresponds to the width equals to diameter of the pin. The grains within the stir zone become equiaxed and often an order of magnitude smaller than the grains in the parent material³. A unique feature of the stir zone is the common occurrence of several concentric rings which has been referred to as an "onion-ring" structure⁴.

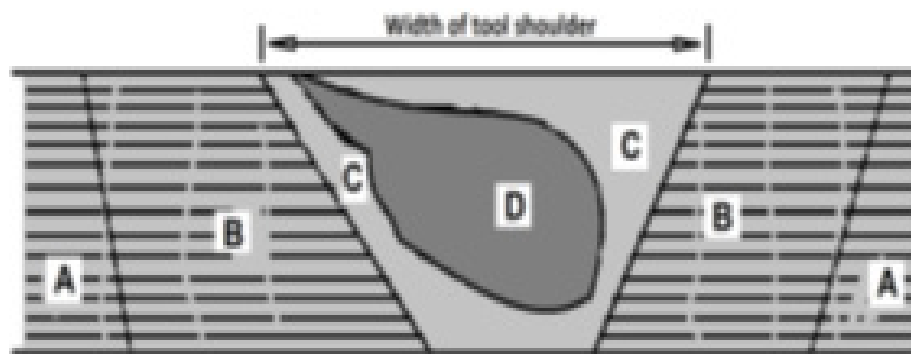

Figure 1. Various microstructural zones in the transverse cross section of FSWed metal plates.

1.2 FSW Parameters

The following parameters need to be mastered for making FSW ideal for welding process:

- Tool rotation speed used to classify angular velocity (ω , rpm) in clockwise or counterclockwise direction.
- Tool traverse speed (v , mm/min) along the line of joint.
- The Forces present in FSW are also an important parameter for the process. The force parallel with the axis of tool rotation (z component) is defined as the “down force”. The force acting in parallel with the welding direction (x component) is known as the “traversing force”, and the force perpendicular to this (y component) is known as the “side force”⁵.
- Tilting angle of tool may be in any desired direction.

2. Literature Survey

There has been extensive study on the mechanical properties and microstructure of friction stir welded aluminum alloys. These studies mainly concentrated on the mechanical properties like tensile strength of a friction stir welded joint and grain size obtained in the weld zone. Some of the review literature studies were exclusively focused on the type of precipitants obtained due to precipitation phenomenon in the welded region. Hardness profiles for different weld regions were experimentally studied. Investigations were made on the effect of rotational speed on microstructure.

Peel et.al. (2003) exhibit the results of mechanical property, microstructural and residual stress investigations of AA5083 Friction Stir Welds produced under varying conditions. The results shows that the yield strength & hardness lower than parent AA5058 due to resulting of

recrystallization in the weld zone. As the transverse speed increased, the tensile stresses appear to be limited to the softened weld zone resulting in a narrowing of the tensile region. The peak longitudinal stresses increased probably due to the reduced time for stress relaxation to occur and steeper thermal gradients during welding as the transverse speed increased.

K. Panneerselvam et al.⁶ found that at constant rotational speed and welding speed square pin profile produces defect free welds but threaded tool pin profile produces less force of polypropylene plates.

Mohsen Bahrami et al.⁷ study the influence of different pin geometry such as square, threaded tapered, triangular, four-flute square, and four-flute cylindrical, of AA7075/SiC nano-composite on microstructure using scanning electron microscopy (SEM) and optical microscopy (OM), measured tensile strength on tensile test machine and concluded that the highest UTS was obtained with triangular pin geometry. Macroscopic fracture observed for specimen welded by four-flute cylindrical pin tool (which is failed in SZ) and remaining specimens fractured in base metal far outside the SZ.

Yong-Jai Kwon et al. performed Friction stir welding on 5052 aluminium alloy plates with a thickness of 2mm was performed. The tool for welding was rotated at speeds ranging from 500 to 3000 r/min under a constant traverse speed of 100 mm/min. The results show that at all tool rotation speeds, defect-free welds are successfully obtained. At 1000, 2000 and 3000 r/min, the welds exhibit very smooth surface morphologies. At 500, 1000 and 2000 r/min onion ring structure is clearly observed in the friction stir welded zone (SZ). Also the region becomes wider as the tool rotation speed is increased. The grain size in SZ is smaller than the that in base metal, and is decreased with a decrease of tool rotation speed. The SZ exhibits higher average hardness than the base metal especially at 500r/min which is 33% greater than that of the base metal. The tensile strength of the friction stir welded (FSWed) plates is similar to base metal (about 204

MPa) at 500, 1000, and 2000 r/min. The elongation of the FSWed plates is lower than that of base metal (about 22%). However, it is noticeable that the maximum elongation of about 21% is obtained at 1000 r/min.

Prasanna P. et al. discussed effect of tool pin profiles and heat treatment process in the friction stir welding of AA6061 aluminium alloy. Four different profiles have been used to fabricate the butt joints by keeping constant process parameters of tool rotational speed 1200rpm, welding speed 14mm/min and axial force 7 KN. Different heat treatment methods like annealing, normalizing and quenching have been applied on the joints and evaluation of the mechanical properties like tensile strength, percentage elongation, hardness and microstructure in the friction stirring formation zone are evaluated. From this investigation, it is found that the hexagonal tool profile produces good tensile strength, percentage elongation in annealing and hardness in quenching process. The maximum tensile strength of 210MPa and 20.9% elongation is observed in hexagonal tool profile with annealing process. The tensile strength and percent of elongation of the hexagonal tool profile with annealing process has reached about 90% and 80% respectively of the parent metal.

S. Ugender et al.² investigation shows that the joint fabricated using tapered cylindrical pin profile exhibited more temperature and superior tensile properties compared to the joints fabricated by straight cylindrical pin profile for friction stir welding of AA2014 Aluminium Alloy.

K. Elangovan et al.⁹ found out the influences of tool pin profile and welding speed for AA2219 aluminium alloy fabricated by the friction stir welding and observed that the square pin profiled tool produces mechanically sound and metallurgical defect free welds compared to other tool pin profiles.

3. Experimental Work

A conventional vertical milling machine was used for FSW process. The assembly of jig and fixture with rotating tool during the FSW process is shown in **Figure 1**. The dimensions of the plate of aluminium alloy AA5052 with a chemical composition as shown in **Table 1** were selected as 200mm x 100mm x 6mm. FSW tool was made from HCHCr D2 material with different tool pin geometries.

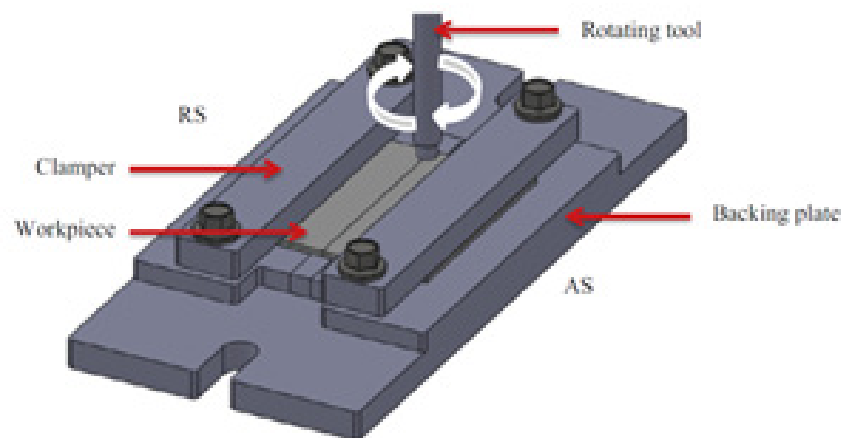

Figure 1. Assembly of jig and fixture with rotating tool.

Table 1. Chemical composition of Al5052

Component	Wt%
Al	95.7 - 97.7
Cr	0.15-0.35
Cu	Max 0.1
Fe	Max 0.4
Mg	2.2 - 2.8
Mn	Max 0.1
Other,each	Max 0.05
Other, total	Max 0.15
Si	Max 0.25
Zn	Max 0.1

Table 2. Typical composition of HCHCr - D2 (wt.%)

%C	Mn	Si	Cr	Mo	Co	Cu	S
1.55	0.60	0.60	13	1.0	1.10	0.25	0.03

Table 3. Physical properties and thermal properties of HCHCr

Density (Kg/m ³)	Quenching Temp.(C ^o)	Modulus of Elasticity (GPa)	Hardness (HRC)	Thermal Conductivity (W/m-K)	Specific Heat Capacity (J/Kg-K)
7.7 x 10 ³	980-1100	210	60-61	20	461

**Figure 2.** Tensile test specimens as per ASTM E8.

The chemical composition and physical properties of tool material are shown in **Table 2** and **3** respectively.

Two tool pin geometries were selected as: (1) Left Handed Threaded Tapper pin-(T1) (2) Square pin-(T2), common basic dimensions such as shoulder diameter, shoulder length, pin diameter, pin length, shank diameter, and shank length for FSW tools are shown in Table 4.

Trial experimentation was done to optimize the FSW parameters in accordance with material. Different com-

bination of rotational speed and welding speed with tool T1 and T2 were done. From trial experimentation and observed welding joints, it was concluded that rotational speeds of 850 and 1250 rpm and welding speeds of 30 and 40mm/min gave best joints. Table 5 shows the tool, rotational speed and welding speed along with specimen number showing the order of experiment to be performed.

Table 4. Basic Dimensions of FSW tools

Parameters	Tool T1	Tool T2
Tool Pin shape	Taper(LHT); pin angle $\alpha=20^\circ$	Diagonal length 5mm
Thread Pitch	1mm	-----
Shoulder diameter	24mm	24mm
Pin diameter		-----
Pin length	5.7mm	5.7mm
Tilt angle	1°	1°
Shoulder Plunge depth	0.2mm	0.2mm

Table 5. FSW Parameters for Experiments

Specimen no.	Tool	Rotational Speed (rpm)	Welding Speed (mm/min)
1	T1	850	30
2	T1	850	40
3	T1	1250	30
4	T1	1250	40

Table 5 Continued

5	T2	850	30
6	T2	850	40
7	T2	1250	30
8	T2	1250	40

4. Result and Discussion

4.1 Appearances of Welded Joints

To investigate the surface appearance of the welding joints macroscopic image were taken. The effect of weld parameters are shown in **Figure**. Defect free welded joints were successfully obtained except for specimen no 1 and 2, where we found tunnel defect at advancing side near the SZ/TMAZ interfaces and extended along the welding direction.

4.2 Tensile Strength Analysis

The Sub-size tensile specimen were prepared as per ASTM-E8/E8M (2012) guidelines⁸ were made shown in Figure 2 and tested on universal tensile strength machine to check UTS and elongation. As mentioned above eight specimen were arranged and welded for analysis and their results are mentioned in Table 6. It was observed that out of eight specimen, specimen 4 obtained high Universal Tensile Strength (UTS) value of 378.12N/mm² with joint efficiency of 80%. Most of the specimen fractured from

Table 6. UTS, Percentage Elongation and Impact Test Results

Specimen no.	Tool	Rotational Speed (rpm)	Welding Speed (mm/min)	UTS (N/mm ²)	% Elongation	Impact Strength(J)
1	T1	850	30	108.33	6.6	08
2	T1	850	40	60.27	5.07	07
3	T1	1250	30	283.61	15.73	40

Table 6 Continued

4	T1	1250	40	378.12	13.33	28
5	T2	850	30	291.38	14.47	32
6	T2	850	40	279.72	14.42	24
7	T2	1250	30	289.44	14.05	34
8	T2	1250	40	283.56	13.67	30

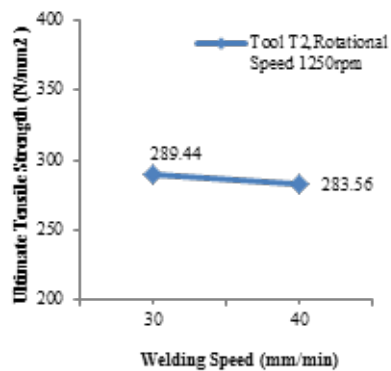
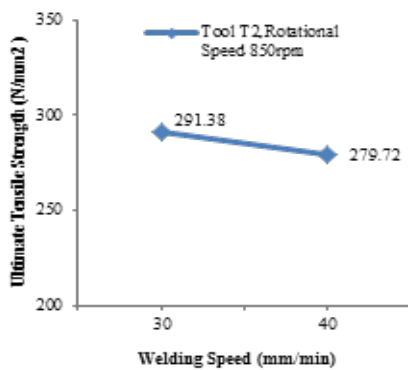
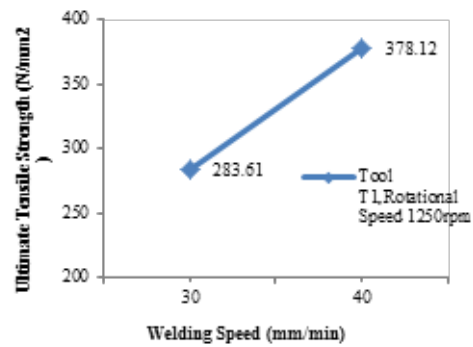
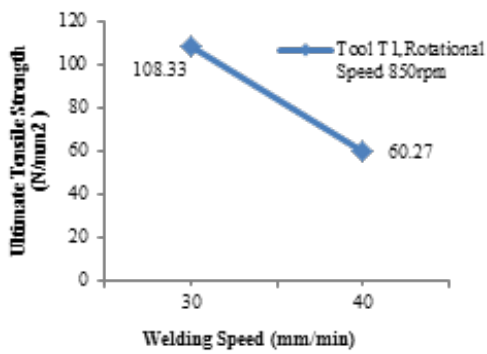

(a)

(b)

Figure 3. (a) UTS at Constant Tool Rotational Speed of 850 rpm for Tool T1 and Tool T2, (b) UTS at Constant Tool Rotational Speed of 1250 rpm for Tool T1 and Tool T2.

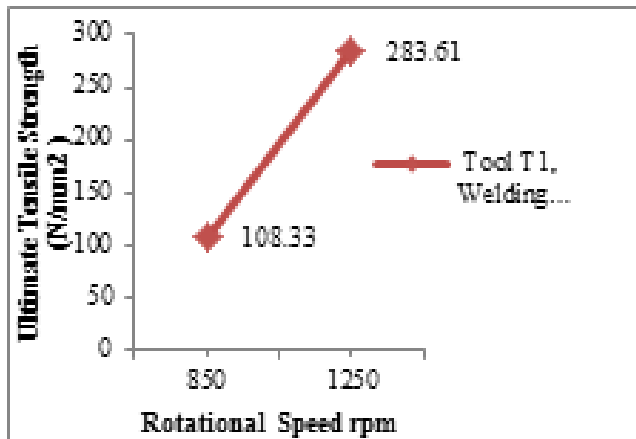

Figure 4. UTS at Constant Welding speed 30mm/min.

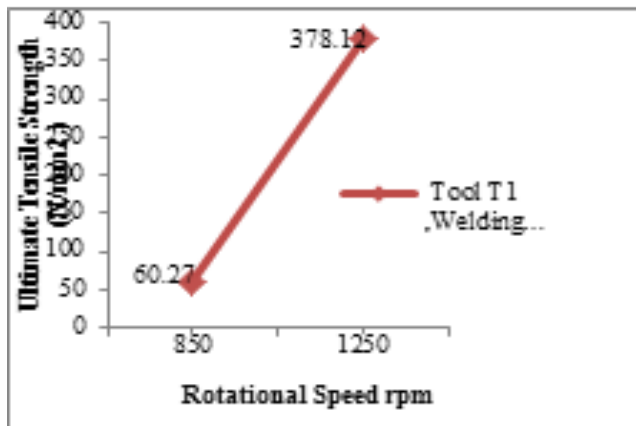
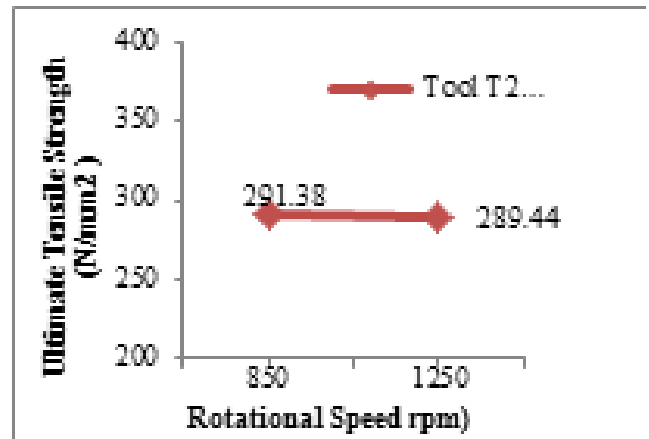
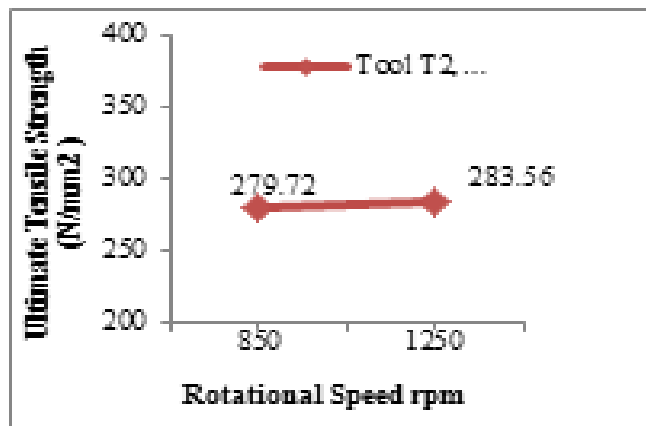

Figure 5. UTS at Constant Welding Speed of 40mm/min.



the area of SZ and TMAZ. The tunnel defects were found in specimen 1 and 2, due to low heat generation there were improper flow of material when tool T1, rotational speed 850 rpm and welding speed 30 and 40 mm/min were used respectively. FSW with tool T2, the specimens were found to be free of tunnel defect. The tensile strength of specimens were changed with variation in welding speed and rotational speed. The welding speeds selected

were 30mm/min and 40mm/min respectively, where as rotational speed 850 rpm and 1250 rpm, respectively.

4.2.1 Effect of Welding Speed and Tool Pin Profile on Tensile Properties

In Figure 3(a) and (b), it was observed that the value of UTS for specimen 5 welded with tool T2, observed more value (291.38N/mm²) as compared to speci-

men 1(108.3338N/mm²) weld with T1 for tool rotation 850 rpm and welding speed 30mm/min. Same trend is observed when compared at welding speed 40mm/min. It is observed that for Tool T1 and tool rotational speed 850rpm, the specimen shows decrease in UTS value even at welding speed increase from 30 to 40 mm/min. At lower tool rotational speed below 1000rpm with tool T1, heat generation at the weld zone was inadequate to strain the plasticized the material that resulted in poor consolidation of material hence result in poor tensile strength of welded joints⁹. With the increase in welding speed from 30 to 40, only specimen welded with parameter Tool T1 and tool rotational speed 1250 shows increase in UTS value, while other shows decreasing trend in UTS value.

4.2.2 Effect of Rotational Speed and Tool Pin Profile on Tensile Properties

As can be seen from Figure 4 there is increase of UTS when tool rotational speed increased from 850 to 1250 for Tool T1 at constant welding speed 30mm/min and 40mm/min. It is well studied that tensile strength of the FSWed joints are highly influenced by tool rotational speed¹⁰. Hassan et al.¹¹ found that ultimate tensile strength and % elongation showed poor performance at lower rotational speed. Tool T2 at constant welding speed 30mm/min and 40mm/min for tool rotational speed 850rpm and 1250 rpm shows better UTS values as compared to tool T1 at sane parameters as shown in Figure 4 and 5. T1 tool (square pin profile) has more swept area as compared to tool T2 (taper threaded pin) results in better flow of material in SZ and advancing side of while FSW process.

5. Conclusions

In this study, effect of tool pin profile, welding speed and tool rotational speed on the tensile strength of the friction stir welded AA 5052 plates was investigated. In a nutshell, the findings throughout the study can be summarized as follows:

- a. AA 5052 alloy was successfully joined by the friction stir welding process except the specimen 1 and 2, which shows tunnel defects, due to inadequate heat generate at weld.
- b. The weld joint produced with Tool T1 and at weld speed 40mm/min and tool rotaion speed 1250rpm gave a maximum tensile strength of 378.12 N/mm².
- c. From the analysis of Table 6 and Figure 3(a) and (b), Figure 4 and Figure 5. It was also observed that better results of UTS was from specimens produced by Tool T2 at welding speed 40mm and 1250 rpm tool rotation speed.

6. Acknowledgments

The authors would like to acknowledge the Bhai Gurdas Institute of Engineering and Technology, Sangrur and Thapar University, Patiala for providing the necessary facilities and resources for this research.

7. References

1. Thomas WM, Nicholas ED, Needham JC, Murch MG, Templesmith P and Dawes CJ. 1991 Dec; G.B Patent 9125978.8.
2. Ugender S, Kumar A, Somi Reddy A. Experimental investigation of tool geometry on mechanical properties of friction stir welding of AA 2014 Aluminium Alloy. *Procedia Materials Science*. 2014; 5:824-31. Crossref.
3. Esparza JA, Davis WC, Trillo EA and Murr LE. Friction stir welding of magnesium alloy AZ31B. *Journal of Materials Science Letters*. 2002; 21:917-20. Crossref.
4. Gurmeet Singh, Kulwant Singh, Jagtar Singh. Effect of Process Parameters on Microstructure and Mechanical Properties in Friction Stir Welding of Aluminum Alloy. *Transaction of Indian Institute of Metals*. 2011 October; 64(4-5):325-30. Crossref.

5. Threadgill P. Terminology in friction stir welding. *Science and Technology of Welding and Joining*. 2007; 12:357-60. Crossref.
6. Panneerselvam K, Lenin K. Investigation on effect of tool forces and joint defects during FSW polypropylene plate. *International Conference on Modeling Optimization and Computing*. 2012; 38:3927-40.
7. Mohsen Bahrami, Mohammad Kazem Besharati Givi, Kamran Dehghani, Nader Parvin. On the role of pin geometry in microstructure and mechanical properties of AA7075/SiC nano-composite fabricated by friction stir welding technique. *Materials and Design*. 2014; 53:519-27. Crossref.
8. ASTM E8/E8M. Standard Test Methods for Tension Testing of Metallic Materials. 2012; 1(C):1-27.
9. Dinaharan I, Murugan N, Parameswaran S. Developing an empirical relationship to predict the influence of process parameters on tensile strength of friction welded AA6061/0-10wt% ZrB₂ in situ composite. *Transactions of the Indian Institute of Metals*. 2012; 62(2):159-70. Crossref.
10. Simar A, Brechet Y, Meester B, de Denquin A, Gallais C, Pardoën T. Integrated modelling of friction stir welding of 6xx series Al alloys: process, microstructure and properties. *Progress in Materials Science*. 2012; 57:95-183. Crossref.
11. Hassan Kh AA, Prangnell PB, Norman AF, Price DA, Williams SW. Effect of welding parameters on nugget zone microstructure and properties in high strength aluminium alloy friction stir welds. *Science and Technology of Welding and Joining*. 2003; 8(4):257-68. Crossref.